

# Tree Runner®

EN Rigging Bollard 71-877, 71-879, 71-818 – Operating Manual

EN



EN The original operating manual is in German

# Contents

<b>About this manual</b>	<b>5</b>
Validity	5
Presentation of warnings	5
Symbols in this manual	6
<hr/>	
<b>Safety instructions</b>	<b>6</b>
Intended use	7
Improper use	7
Qualification of personnel	7
You must observe these points	8
General safety instructions	8
Safety instructions regarding the workplace	8
Safety information on ergonomics at the workplace	8
Safety information before operation	9
Safety information during operation	9
Safety information after operation	9
Safety instructions regarding load ropes	9
Conduct in emergencies	9
Personal protective equipment	10
<hr/>	
<b>Design and function</b>	<b>11</b>
Overview of the Rigging Bollard	11
Function of the Rigging Bollard	13
Wearing parts	13
<hr/>	
<b>Included in the delivery</b>	<b>14</b>
Check that the delivery is complete	14
Checking for transport damage	14
<hr/>	
<b>Assembly of the Rigging Bollard</b>	<b>15</b>
Assembling the Rigging Bollard	15
<hr/>	
<b>Commissioning and operation</b>	<b>16</b>
Activities before use	16
Communication	17

Dynamic lowering	18
Position of the ground man	18
Position of the climber	19
Possibilities of rope layouts	20
Dynamic lowering the load	22
<hr/>	
<b>Transport</b>	<b>23</b>
<hr/>	
<b>Cleaning and maintenance</b>	<b>24</b>
Cleaning the Rigging Bollard	24
<hr/>	
<b>Decommissioning and disposal</b>	<b>25</b>
<hr/>	
<b>Storage</b>	<b>25</b>
<hr/>	
<b>Repair</b>	<b>26</b>
<hr/>	
<b>Technical specifications</b>	<b>27</b>
General data	27
Type plate	27
<hr/>	
<b>Accessories and spare parts</b>	<b>28</b>
<hr/>	
<b>Dealer service</b>	<b>30</b>
<hr/>	
<b>Warranty</b>	<b>30</b>
<hr/>	
<b>Guarantee</b>	<b>30</b>
<hr/>	
<b>Index</b>	<b>31</b>

# About this manual

## Validity

This manual is applicable for the following rigging bollard variants:

Device	Type
Tree Runner Rigging Bollard P3000	71-877
Tree Runner Rigging Bollard P500	71-879
Tree Runner Rigging Bollard	71-818

It is intended for professional workers in the tree care sector.

The manual contains important information on the safe and proper transport, assembly and installation, commissioning, operation, use and maintenance of the rigging bollard and also how to independently rectify simple faults.

EN

## Presentation of warnings



 <b>SIGNAL WORD</b>
<p><b>Nature and source of hazard!</b></p> <p>Consequences</p> <ul style="list-style-type: none"> <li>› Hazard avoidance</li> </ul>

- The **warning sign** (warning triangle) indicates risks to life and limb.
- The **signal word** indicates the severity of the hazard.
- The section "**Nature and source of hazard**" indicates the nature or source of the hazard.
- The section "**Consequences**" describes the possible consequences of non-observance of the warning.
- The section "**Hazard avoidance**" indicates how the hazard can be avoided. It is essential that you implement these hazard avoidance measures!

The signal words have the following meanings:

Warning word	Meaning
<b>DANGER!</b>	Indicates a hazard that certainly will lead to severe, even fatal injuries if not avoided.
<b>WARNING!</b>	Indicates a hazard that will possibly lead to severe, even fatal injuries if not avoided.
<b>CAUTION!</b>	Indicates a hazard that will lead to light to moderately severe injuries if not avoided.
<b>ATTENTION!</b>	Indicates possible material damage. The environment, material or the device itself may be damaged if the hazard is not avoided.

## Symbols in this manual

Symbol	Meaning
	If this information is ignored, this can result in impairments to the operating process.
	Required action: Describes actions that must be performed.

## Safety instructions

The rigging bollard has been manufactured in accordance with generally accepted good engineering practice. Nevertheless, there is a risk of personal injury and material damage if you do not observe the following basic safety instructions and the warnings before operating instructions in this manual.

- › Read this manual through carefully and fully before you work with the rigging bollard.
- › Keep the manual in a safe place so that it is in a legible condition.
- › Make sure that the manual is always available to all users.
- › Always ensure that this manual is passed on to third parties together with the rigging bollard.

## Intended use

The rigging bollard is used for dynamic catching and releasing of wood loads (branches, crown parts, trunk pieces etc.) during pruning work. It is attached to the tree trunk.

## Improper use

Any improper use is prohibited. Improper use includes

- converting, modifying or disabling the rigging bollard,
- removing or modifying safety devices,
- any other use of the rigging bollard apart from those uses described in the "Intended use" chapter,
- using the rigging bollard under operating conditions that deviate from those specified in this manual.

Improper use of the rigging bollard voids all guarantee claims.

The manufacturer is not liable for damage to the rigging bollard or for personal injuries that result from improper use.

## Qualification of personnel

The rigging bollard may only be operated, maintained and repaired by persons with appropriate training. It is essential to have been familiarised with the device and the associated hazards by reading this manual.

People who assemble, operate, disassemble or maintain the rigging bollard must not be under the influence of alcohol, drugs or medication which could impair their reactions.

People under the age of 18 must not be employed on the rigging bollard. However, it is permissible to allow persons over 16 years of age to perform such work under the supervision of a qualified person where this is required to achieve a training objective.

Persons operating the rigging bollard must also be physically capable of supporting the weight of the tree part removed.

## You must observe these points

### General safety instructions

- › Follow the instructions in this manual to avoid hazards and material damage.
- › Observe the relevant accident prevention regulations as well as the other generally accepted safety, occupational health and road traffic regulations.
- › Set up a suitable safety area.
- › Operate the device from a safe distance.
- › Do not load the rigging bollard beyond the permissible load capacity (see chapter „Technische Daten“ auf Seite 27).
- › Tie long hair into a braid or use a suitable protective hood.
- › When working with the rigging bollard, check the tension of the rope.
- › Participate regularly in advanced training courses (rigging courses).

### Safety instructions regarding the workplace

- › Do not stand under suspended loads.
- › Make sure that the working area is clear of wood scraps, obstacles and objects likely to cause tripping.
- › Keep walking and rope paths clear.
- › Ensure that there is as little wood dust as possible in the environment when working and remove wood dust from the work area.
- › Ensure there is sufficient lighting in the workplace.
- › Ensure that you have a level area with safe footing and with sufficient freedom of movement.

### Safety information on ergonomics at the workplace

- › Avoid unnatural postures.
- › Take the correct working posture.
- › Wear personal protective equipment (see „Persönliche Schutzausrüstung“ auf Seite 10).



### **Safety information before operation**

- › Check the device for possible damage and begin the work when the rigging bollard is functioning faultlessly.
- › Check the rope for damage and knots.

### **Safety information during operation**

- › Keep a sufficient distance from the rigging bollard.
- › Only operate the rigging bollard with two hands.
- › Do not wrap the rope around the body or limbs.

### **Safety information after operation**

- › Check the device for possible damage and do not use it again until any damage has been repaired.
- › Check the rope and the tension straps for damage.

### **Safety instructions regarding load ropes**

- › Only use ropes made of polyester or polyamide fibre with an elongation value of < 5 %.

### **Conduct in emergencies**

If, for example, there is a direct risk of personal injuries or damage to the rigging bollard due to malfunctions or hazardous situations:

- › Inform the rigging partner immediately of the danger.
- › Abort the work.

## Personal protective equipment

- › Always wear the following personal protective equipment:
  - Head protection
  - Safety shoes of safety class S3
  - Protective hood for long hair
  - Close-fitting clothing
  - Protective gloves according to DIN EN 388 from 3xxx made of LEATHER
  - Eye protection (when sawing tree parts)
  - High visibility vest (in the sphere of public highway traffic)

# Design and function

## Overview of the Rigging Bollard

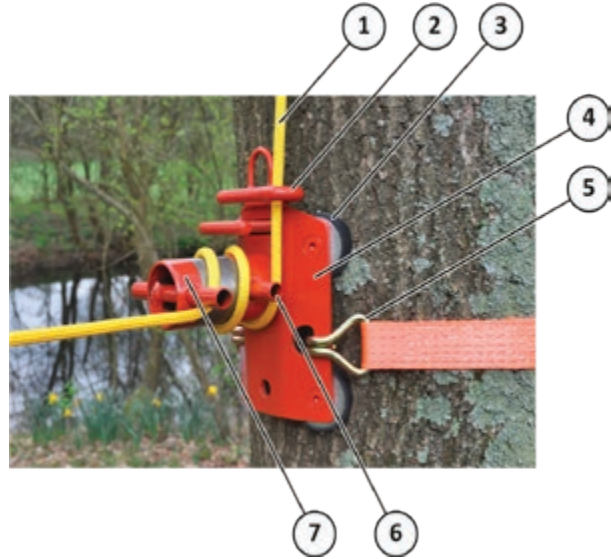

EN

**Fig. 1:** Rigging Bollard 71-879

<b>1</b>	Load rope	<b>5</b>	Tension strap with hook
<b>2</b>	Rope sliding bracket	<b>6</b>	Deflection tubes
<b>3</b>	Rubber plate	<b>7</b>	Brake pipe
<b>4</b>	Base plate		

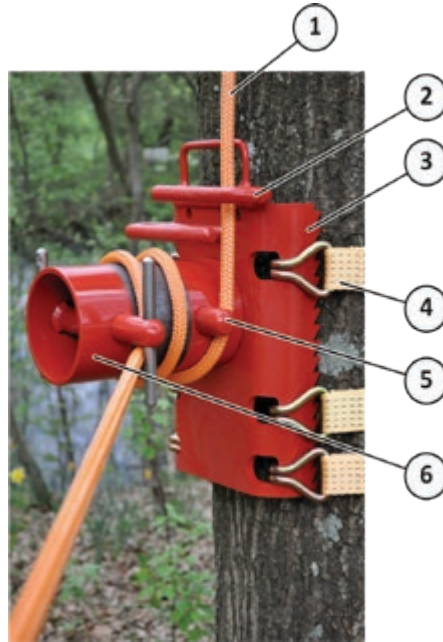

**Fig. 2:** Rigging Bollard 71-877

<b>1</b>	Load rope	<b>4</b>	Tension strap with hook
<b>2</b>	Rope sliding bracket	<b>5</b>	Deflection tubes
<b>3</b>	Base plate	<b>6</b>	Brake pipe

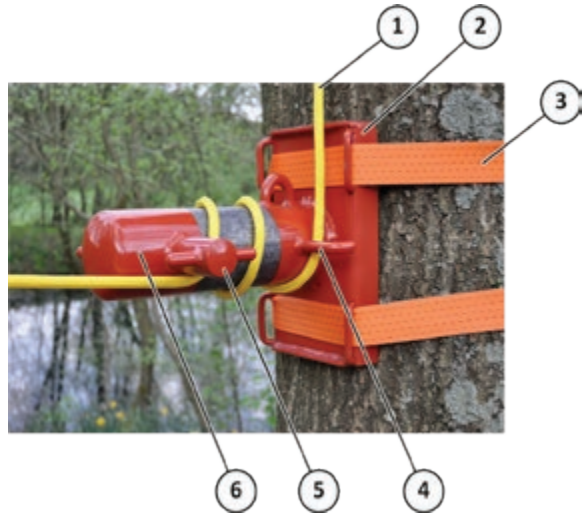

EN

**Fig. 3:** Rigging Bollard 71-818

<b>1</b>	Load rope	<b>4</b>	Rope sliding bracket
<b>2</b>	Base plate	<b>5</b>	Deflection tubes
<b>3</b>	Tension strap	<b>6</b>	Brake pipe

## Function of the Rigging Bollard

Depending on the model, the rigging bollard is attached to a tree trunk with one to three tension straps. The removed part of the tree is lowered in a controlled manner on a rope wrapped around the brake pipe of the rigging bollard. Depending on the weight of the load, the number of windings of the rope must be adjusted.

## Wearing parts

Wearing parts such as ropes and belts are excluded from warranty claims.

- › You can reorder them if necessary from your dealer.

## Included in the delivery

### Check that the delivery is complete

The following are supplied as standard with the rigging bollard:

- Rigging Bollard
- Operating manual
- Tension straps (optional)

### Checking for transport damage

You can recognise visible transport damage through damaged packaging or scratched and deformed parts on the rigging bollard.

- › Immediately note damage on the delivery note: both on the copy that you retain and on the delivery note that you must sign.
- › Get the delivering party (driver) to countersign.

If the driver refuses to confirm the transport damage, it is better to completely refuse to accept the delivery and inform us immediately. A retrospective claim without direct comment on the delivery note will not be recognised by the carrier or by the transport insurer.

If you suspect hidden transport damage:

- › Report the hidden transport damage within two days at the latest, i.e. you must examine the delivered goods within this period. Reports of damage after this period are not usually accepted.
- › In any event, note on the delivery notes: "The delivery is accepted subject to reservation because of suspected transport damage."

The insurers of carriers are often sceptical and refuse compensation payments. Therefore, try to clearly document the damage (with a photo, for example).

# Assembly of the Rigging Bollard

## Assembling the Rigging Bollard



### WARNING

#### Danger due to incorrect attachment of the rigging bollard!

Injuries possible due to loose or twisted straps.

- › Check the belt for knots and twists before assembly.

- › Attach the rigging bollard to the tree trunk with the tension straps. Make sure that the strap is as level as possible with the tree trunk.

- i** The rigging bollard must always be attached to a solid, stable tree trunk. This tree trunk must be free of vegetation such as moss or ivy.

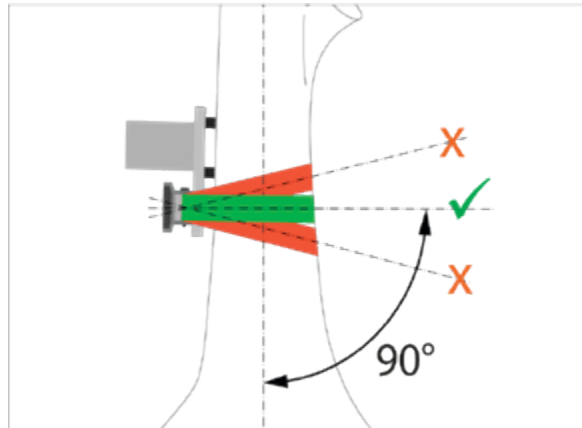

**Fig. 4:** Correct assembly of the tension strap

- › Check the strap tension.

# Commissioning and operation

## Activities before use



### WARNING

#### Risk of injury from damaged materials!

Cracks in the tension strap, the load rope or the bollard can lead to uncontrolled falling of the loads.

- ▶ Check all components of the rigging bollard for damage before operation.
- ▶ Replace any damaged components.

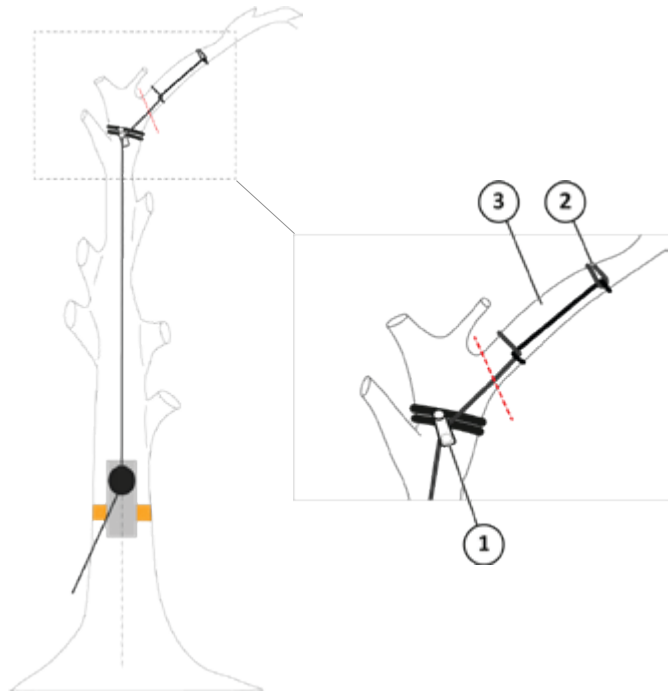

Fig. 5: Preparatory work



- › Attach a pulley **(1)** to the tree trunk.
- › Guide the load rope through the deflection pulley.



## WARNING

### Risk of injury due to obstruction of the load rope!

Due to poor all-round visibility, the climber may inadvertently tie in the load rope with his safety rope.

- › Both as a climber and as a ground man, make sure that the load rope is not obstructed by safety ropes.

- › Attach the end of the rope **(2)** to the part of the tree to be removed **(3)**.
- › Make sure that the rope runs vertically into the bollard from above.

## Communication

Communication between the rigging partners is safety relevant. Depending on the point of view of the ground man or the climber, the overview of the course of ropes, cuts, inclinations of tree parts as well as the estimation of the weight of the tree parts can be very different. Helmet radio and/or predetermined hand signals facilitate communication during work.

- › Check the procedure of your rigging partner according to the **four eyes principle**.
- › In the event of unclear and dangerous situations, interrupt work at short notice with a previously defined **stop signal**.



Working in a changing position (climber/ground man) allows a better understanding of the work and safety aspects of the respective work area.

## Dynamic lowering

The dynamic lowering of loads is used to relieve the load on all components that are used during the lowering process. This prevents sudden impact forces that can affect the load rope, tree trunk and working position of the ground crew when falling down.

### Position of the ground man

The optimum position for the ground man is laterally at a 90° angle to the rigging bollard. This prevents unnecessary deflections of the rope and the rope cannot slip off the brake tube.



### WARNING

#### Risk of injury through unsuitable gloves!

The load rope can slip through wet or slippery gloves or gloves unsuitable for gripping. The load can then no longer be lowered in a controlled manner.

- › Use gloves with which you can inspect the load rope.
- › Inspect the gloves for damage before each use.



### WARNING

#### Risk of injury from stumbling in the working area!

The ground man may trip over objects in the working area when lowering.

- › Make sure that the working area is clear of wood scraps, obstacles and objects likely to cause tripping.
  - › Keep walking and rope paths clear.
- 
- › After consultation with the climber, wrap the load rope with the appropriate assignment (see chapter „Möglichkeiten der Seilbelegungen“ auf Seite 20) around the rigging bollard.
  - › Position yourself at a safe distance to the side of the bollard.
  - › Let the rope sag slightly. Do not keep the rope taut.
  - › Make sure that you can always hold the rope securely with both hands. Do not wrap the rope around the body or limbs.

## Position of the climber



### WARNING

#### **Risk of injury due to incorrect position of the climber!**

The climber can be thrown away or hit by rocking the separated tree part.

- › Position yourself clearly above the planned braking point when lowering the detached tree part.

## Possibilities of rope layouts



### CAUTION

#### **Danger due to incorrect rope windings!**













Incorrect rope windings have a considerable effect on the braking behaviour and wear of the rope.

- › Wind up the rope with the appropriate covering only in the area between the deflection tubes.

Depending on the weight of the tree part to be lowered, the correct number of windings of the load rope around the brake pipe must be selected.

- i** The less windings are made around the brake tube, the more dynamically the load can be lowered, as there is less friction between rope and brake tube.

However, too few windings can lead to the load not being held and falling to the ground uncontrollably.

	71-877	71-879	71-818
1/4			
3/4			
1 1/4			
1 3/4			

## Dynamic lowering the load

 The tree part to be removed must be as small as possible and as large as necessary. **Small loads are safe loads.**

Instructions for the climber:

- › Carry out a careful visual inspection of the fall area.
- › Saw the tree part so that it can be dropped in a controlled manner.
- › Drop the load in a controlled manner after contact with the ground man and a clear signal (call, whistle).

Instructions for the ground man:

- › Wait for the signal from the climber.
- › Allow the load to fall freely to the planned braking point.
- › Stay where you are whilst it falls. Do not go backwards to put more tension on the rope.
- › Lower the load slowly.
- › The rigging bollard can slide up a few centimetres during the first operation. Check the strap tension before further work.

## Transport

### ATTENTION

**Damage to the device due to transport with other materials!**

If the rigging bollard is transported together with abrasive or corrosive materials or equipment, it may be damaged.

- › Do not put the device in contact with abrasive or corrosive materials.
- › Transport the rigging bollard in a separate container.

### ATTENTION

**Damage to the device due to improper transport!**

Impacts against the transport container can weaken the material of the rigging bollard and cause severe and even invisible damage such as hairline cracks.

- › Secure the transport container against falling or impacts.

## Cleaning and maintenance



### WARNING

#### **Danger when performing maintenance, servicing and cleaning work during operation!**

Injuries are possible.

- › Disassemble the rigging bollard before maintenance, servicing and cleaning work.



### CAUTION

#### **Risk due to the use of non-genuine parts!**

The use of non-genuine parts can lead to injuries and damage to the rigging bollard.

- › Only use operating equipment and spare parts permitted for use with the rigging bollard.

## Cleaning the Rigging Bollard

### ATTENTION

#### **Damage to the rigging bollard through improper cleaning!**

Improper cleaning and incorrect handling of the cleaning agents can cause damage to the rigging bollard.

- › Use lukewarm water and if necessary a mild detergent for cleaning.
- › Follow the instructions for use on the container of the cleaning agent.

Perform the following work after each use:

- › Remove sawdust with compressed air, a brush or a vacuum cleaner.
- › Clean all moving parts.
- › Clean all surfaces that may come into contact with the rope.
- › Remove resin residue from the surface of the rigging bollard, tension strap and rope.



Resin can be removed with common agents for maintenance and care.



## Decommissioning and disposal

If the rigging bollard is no longer usable and must be scrapped, decommission and disassemble it.

- › During the scrapping process, note that the rigging bollard's basic materials can be reused in the recycling process.

**i** The manufacturing company rejects all responsibility for any personal injury or material damage that is caused by reusing parts, where these are used for any purpose other than the original material purpose.

When disposing of the rigging bollard or its components:

- › Observe the nationally applicable regulations and directives.

## Storage

- › Only store the rigging bollard in enclosed rooms.
- › Ensure that the storage room is well ventilated and dry.
- › Clean the rigging bollard thoroughly before storing it for a longer period of time (see chapter „Rigging-Poller reinigen“ auf Seite 24).
- › If light flash rust has formed in the area of the brake due to storage, remove it with very fine greaseproof paper.
- › Then clean the bollard (see chapter „Rigging-Poller reinigen“ auf Seite 24).

## Repair



### WARNING

**Danger during maintenance, servicing and cleaning work due to unqualified personnel!**

Maintenance and cleaning may only be carried out in a service workshop.

› In this event, contact customer services.

If you are not able to repair the rigging bollard yourself, contact your dealer or an authorised repair workshop.



Before you contact your dealer, an authorised repair workshop or the manufacturer, please note the specifications and the model number of the device. These details are required to rectify the problem or order spares.

# Technical specifications

## General data

Technical specifications	71-877	71-879	71-818
Bollard material	Steel	Steel	Steel
Bollard diameter	140 mm	76 mm	100 mm
Permissible rope diameter	20 mm	16 mm	18 mm
Permissible payload	3000 kg	500 kg	1000 kg
Number of straps	3	1	2
Tensile force of the strap	2.5 t/5 t*	2.5 t/5 t*	5 t*
Tensioning force of the strap	300 daN	300 daN	500 daN
Weight	16 kg	5.8 kg	7.8 kg

\* with strapping

## Type plate





**Fig. 6:** Type plate



<b>1</b>	Note "Read instructions"	<b>5</b>	Item number
<b>2</b>	Model designation	<b>6</b>	Serial number
<b>3</b>	Payload of the device		
<b>4</b>	Max. diameter of the rope		

## Accessories and spare parts



Unsuitable accessories, consumables and spare parts can impair function and safety, and have the following consequences:

- Endangerment of persons
- Damage to the rigging bollard
- Damage to the rope and tension strap
- › Only use genuine accessories, consumables and spare parts.
- › Only use technically faultless accessories and spare parts.

For 71-879	Art. no.	Name	Quantity
	71-879/P	<p>Holding plate for rigging bollards</p> <p>For extreme loads during felling, a holding plate can be hooked in, which is sawn into the tree.</p> <ul style="list-style-type: none"> <li>• Dimensions: 120 mm wide, 140 mm deep,</li> <li>• Incision depth: 90 mm</li> <li>• Weight: 1.3 kg</li> </ul>	1
	71-879/G	Spare rubber plate	1
	44-015	<p>Lashing strap</p> <ul style="list-style-type: none"> <li>• Tensile force: 2.5 t direct/5 t in strapping</li> <li>• Preload force: 300 kg</li> <li>• Material: Polyester</li> <li>• Strap width: 50 mm</li> </ul>	1

For 71-877	Art. no.	Name	Quantity
	44-015	Lashing strap <ul style="list-style-type: none"> <li>• Tensile force: 2.5 t direct/5 t in strapping</li> <li>• Preload force: 300 kg</li> <li>• Material: Polyester</li> <li>• Strap width: 50 mm</li> </ul>	1
	44-012/6.0	Tension strap with hook Is stretched around the tree first. Then hang the bollard in the hook. A simple assembly aid. <ul style="list-style-type: none"> <li>• Length: 6 m</li> <li>• Weight: 772 g</li> </ul>	1

EN

For 71-818	Art. no.	Name	Quantity
	44-013/4.0	Tension strap For attaching the bollard to the tree (two pieces required). With long lever ratchet. <ul style="list-style-type: none"> <li>• Strap width: 50 mm</li> <li>• Permissible load 50 kN (~ 5 t)</li> <li>• Tear resistance: 100 kN (~ 10 t)</li> <li>• Preload force: 500 daN with 50 kg manual force</li> <li>• Preload force: 750 daN with 75 kg manual force</li> <li>• Length: 4 m</li> </ul>	1
	44-013/6.0	Tension strap For attaching the bollard to the tree (two pieces required). With long lever ratchet. <ul style="list-style-type: none"> <li>• Strap width 50 mm</li> <li>• Permissible load 50 kN (~ 5 t)</li> <li>• Tear strength 100 kN (~ 10 t)</li> <li>• 500 daN preload force at 50 kg manual force</li> <li>• 750 daN preload force at 75 kg manual force</li> <li>• Length: 6 m</li> </ul>	1

## Dealer service

Our dealer service will be happy to help with your queries about the rigging bollard.

## Warranty

The statutory warranty period applies to the device. The vendor must be immediately notified of defects which are demonstrably attributable to material or assembly errors. Proof of purchase for the device must be provided by submitting the invoice and the receipt. The warranty for parts is void if the faults are due to natural wear and tear, the effects of temperature and weather, as well as due to defects as a result of improper assembly, operation or force. Furthermore, no warranty is provided for damage caused by improper use of the device e.g. improper modifications or repair work carried out independently by the owner or third parties, as well as if it was deliberately overloaded.

Wearing parts with a limited lifetime (e.g. ropes and straps) as well as all setting and adjustment work, are completely excluded from the warranty.

## Guarantee

The warranty period is 24 months for exclusively private use, 12 months from the date of delivery for commercial or professional use or rental. The above is without prejudice to the statutory warranty period. Guarantee claims must always be supported by the buyer by means of the original purchase document. A copy thereof is to be appended to the guarantee application. Buyer address and machine type must be clearly identifiable for professional or commercial use.

Defects occurring during the guarantee period due to faults in material or manufacture shall be remedied by repairs if they have arisen in spite of proper operation and maintenance of the machine.

# Index

## A

Accessories 28  
Assembly 15

## B

before use 16

## C

Cleaning 23, 24  
Commissioning 164  
Communication 17  
Conduct in emergencies 9

## D

Decommissioning 25  
Design 11  
Disposal 25  
Dynamic lowering 17, 22

## F

Faults 26

## G

Guarantee 30

## H

Helmet radio 17

## I

Improper use 7  
Included in the delivery 14  
Intended use 7

## M

Maintenance 24  
Mode of operation 13

## O

Operation 16

## P

Personal protective  
equipment 10  
Position  
Climber 19  
Ground man 18

## Q

Qualification of personnel 7

## S

Safety instructions 6  
after operation 9  
before operation 9  
during operation 9  
general 8  
on workplace 8  
equipment 9  
Service 30  
Spare parts 28  
Storage 25  
Strap tensioning 28  
Symbols  
in the manual 6

## T

Technical specifications 26  
Transport 23  
Transport damage 14  
Type plate 27

## V

Validity of the guide 5

## W

Warnings  
Presentation 5  
Warranty 30  
Wearing parts 13

# Tree Runner®

[www.treerunner.de](http://www.treerunner.de)

## Grube KG

D-29646 Bispingen · Tel. (05194) 900-0 · Fax 900-270

E-Mail: [info@grube.de](mailto:info@grube.de) · [www.grube.de](http://www.grube.de)

Management: Dr Gunther Grube

Lüneburg District Court HRA No. 100717 ·

VAT ID DE 1163 80 250